

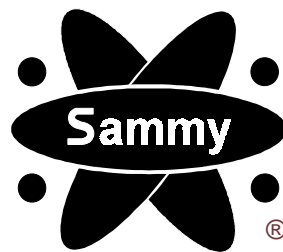

CONVERSION KIT

Instructions



American Sammy Corporation

901 Cambridge Drive
Elk Grove Village, IL 60007
Phone: (708) 364-9787
Fax: (708) 364-9831

GAME CONVERSION OVERVIEW

This ZOMBIE RAID kit facilitates conversion of a **MIDWAY REVOLUTION X** or **TERMINATOR 2** game to an upright ZOMBIE RAID game. By doing a few simple steps involving changing of the gun assys, the game P.C.Board, associated harnesses and modification of the game cabinet graphics to accomplish this task.

These instructions describe the steps required to convert an existing **MIDWAY REVOLUTION X** or **TERMINATOR 2** game, then describes adjustments and tests associated with your NEW ZOMBIE RAID.

CONTENTS

1. KIT PACKAGE CONTENTS	Page 1, 2
2. GUN ASSEMBLY	Page 3, 4
3. CONNECTOR TABLES	Page 5, 6
4. DIP SWITCH TABLES	Page 7
5. LAYOUT OF P.C.BOARDS - MAIN P.C.BOARD - SOLENOID COIL INTERFACE BOARD	Page 8
6. INTERFACE HARNESS DIAGRAM	Page 9
7. HOW TO ASSEMBLE THE KIT - WIRING INSTRUCTIONS FOR REVOLUTION X - WIRING INSTRUCTIONS FOR TERMINATOR 2	Page 10, 11, 12
8. TEST MENU - HOW TO MANUALLY ADJUST THE GUN	Page 13, 14, 15

1. KIT PACKAGE CONTENTS

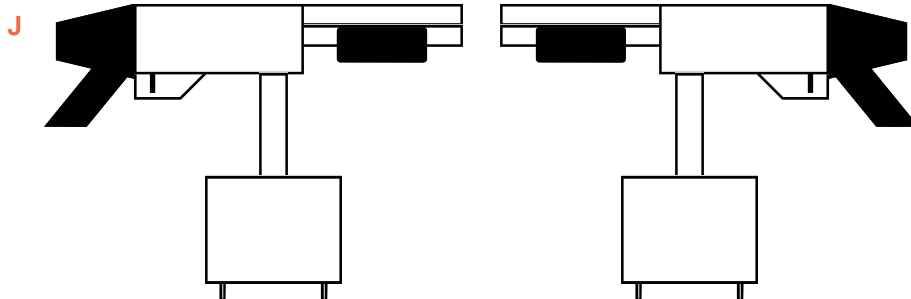
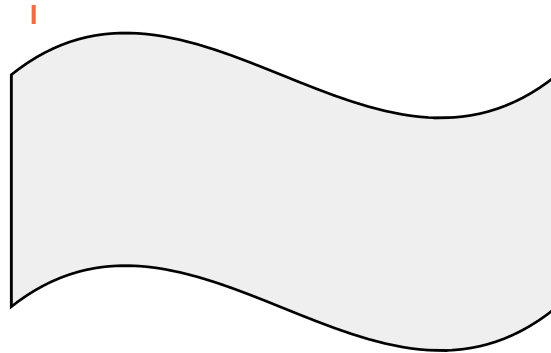
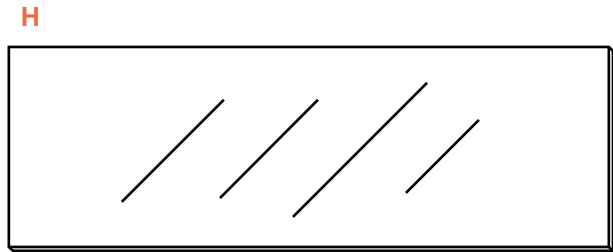
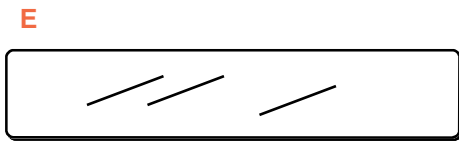
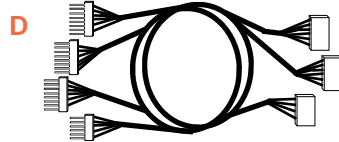
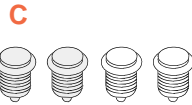
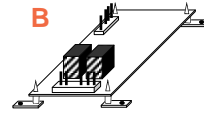
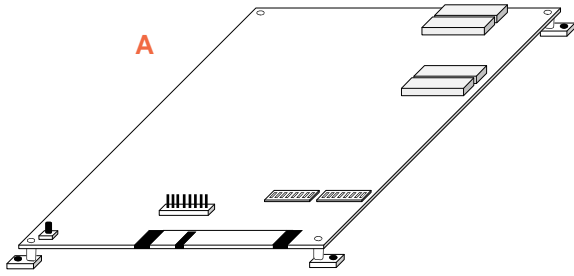



ITEM	DESCRIPTION	PART NUMBER
A	Main P.C.Board	20-10-001
B	Solenoid Coil Interface Board	20-20-030
C	Push Button Assy (Red: 2 units, Blue: 2 units)	99-50-001 (Red) 99-50-002 (Blue)
D	Interface Harness	20-60-680
E	Instruction Decal Sheet	20-30-210
F	Marquee Styrene	20-30-100
G	Conversion Kit Instructions	20-30-300
H	Clear Lexan Control Panel Cover	99-30-502
I	Control Panel Overlay	20-30-150
J	Gun Assy (2 units)	20-50-300
	Gun Grip	20-50-301
	Gun Pump Handle	20-50-302

2. GUN ASSEMBLY

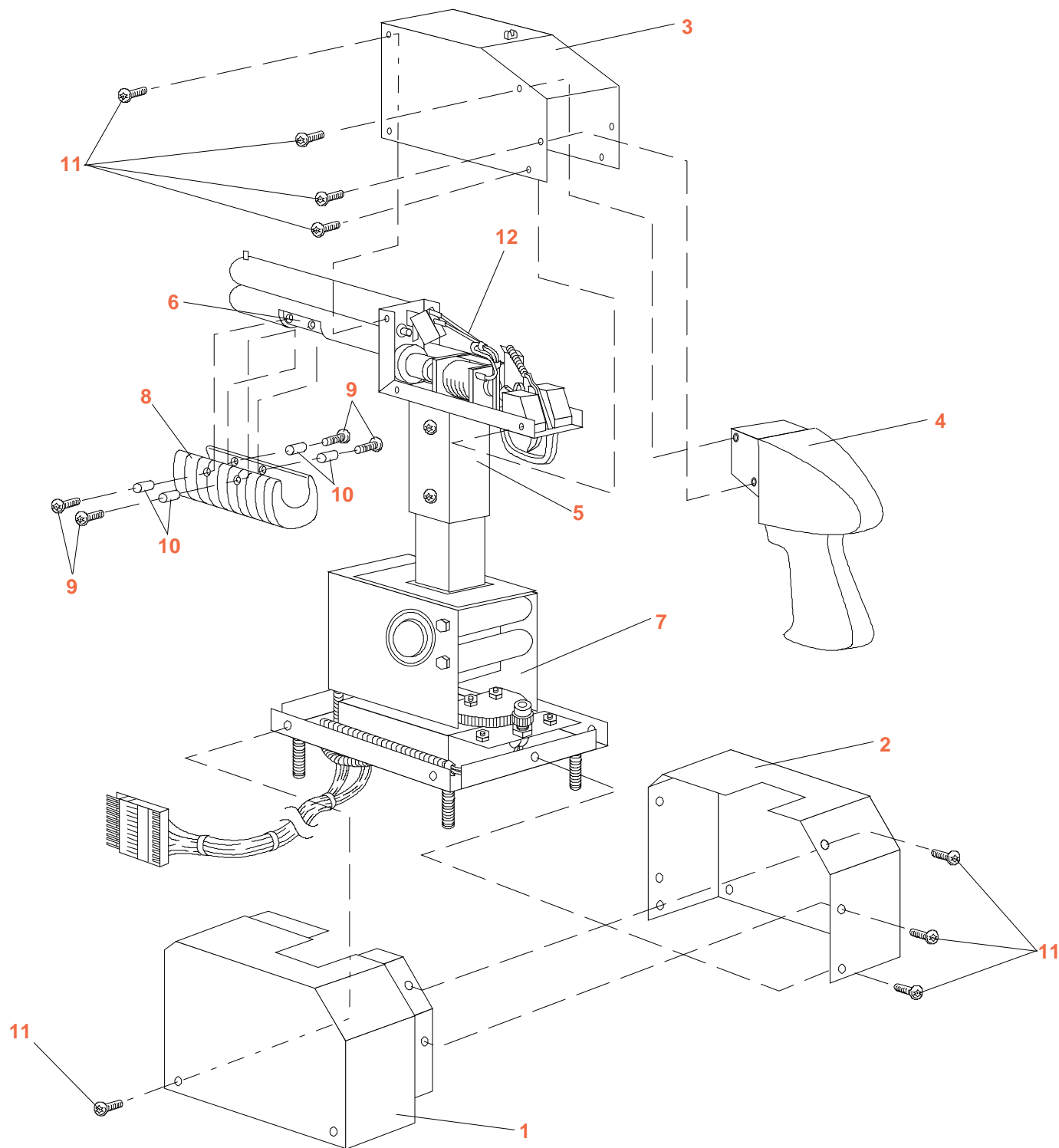



ITEM	DESCRIPTION
1	Base Housing, Left
2	Base Housing, Right
3	Gun Cover Housing Fish Paper
4	Gun Grip
5	Gun Body Assy Trigger Spring, Trigger Microswitch, Trigger Mounting Block Solenoid Coil Plunger Spring, Plunger Microswitch, Pump Plastic Nub
6	Pump Shaft Pump Actuator Spring, Pump Spacer, Pump Bushing
7	Potentiometer Gear, Segment, 32P Gear, Segment, Hubless Gear, Spur
8	Pump handle Pump handle adaptor
9	T-15 Trex Wrench Screw
10	Spacer, Pump Handle
11	T-20 Trex Wrench Screw
12	Wiring Harness, Upper

3. CONNECTOR TABLES



JAMMA CONNECTOR					
MAIN P.C.BOARD					
SOLDER SIDE			COMPONENT SIDE		
FUNCTION	COLOR	PIN #	PIN #	COLOR	FUNCTION
GROUND	BLK	A	1	BLK	GROUND
GROUND	BLK	B	2	BLK	GROUND
(+)5VDC	RED	C	3	RED	(+)5VDC
(+)5VDC	RED	D	4	RED	(+)5VDC
		E	5		
(+)12VDC	BLU	F	6	BLU	(+)12VDC
KEY		H	7		KEY
COIN METER B		J	8	BLU/BRN	COIN METER A
COIN LOCKOUT B		K	9		COIN LOCKOUT A
SPEAKER(-)	BLK	L	10	WHT/BLK	SPEAKER(+)
		M	11		
VIDEO GREEN	GRN	N	12	RED	VIDEO RED
VIDEO SYNC	WHT	P	13	BLU	VIDEO BLUE
SERVICE CREDIT SWITCH	BRN/WHT	R	14	BLK	VIDEO GROUND
		S	15	WHT/GRY	TEST SWITCH
COIN SWITCH B		T	16		COIN SWITCH A
2P START BUTTON		U	17		1P START BUTTON
		V	18		
		W	19		
		X	20		
		Y	21		
2P GUN TRIGGER		Z	22		1P GUN TRIGGER
2P GUN PUMP SWITCH		a	23		1P GUN PUMP SWITCH
		b	24		
		c	25		
		d	26		
GROUND	BLK	e	27	BLK	GROUND
GROUND	BLK	f	28	BLK	GROUND



CN2 - 8 PIN SUB CONNECTOR		
MAIN P.C.BOARD		
PIN #	COLOR	FUNCTION
1	RED	+5VDC
2	ORG	1P GUN POT. (X)
3	ORG/WHT	1P GUN POT. (Y)
4	GRN	2P GUN POT. (X)
5	GRN/WHT	2P GUN POT. (Y)
6	VIO	1P SOLENOID COIL PULSE
7	VIO/WHT	2P SOLENOID COIL PULSE
8	BLK	GROUND

J1 - 5 PIN CONNECTOR		
SOLENOID COIL INTERFACE BOARD		
PIN #	COLOR	FUNCTION
1	RED	+5VDC
2		NOT USED
3	BLK	GROUND
4	VIO	1P SOLENOID COIL PULSE
5	VIO/WHT	2P SOLENOID COIL PULSE

J2 - 6 PIN CONNECTOR		
SOLENOID COIL INTERFACE BOARD		
PIN #	COLOR	FUNCTION
1	GRN/BLU	1P SOLENOID COIL
2	GRN/YEL	2P SOLENOID COIL
3	ORG	+20VDC IN
4		KEY
5	BLK/YEL	GROUND, COIL
6	BLK/YEL	GROUND, COIL

4. DIP SWITCH TABLES



DIP SWITCH 1		SWITCH POSITIONS							
FUNCTIONS	SETTING	1	2	3	4	5	6	7	8
COIN CHUTE 1	1 COIN 1 CREDIT	OFF	OFF	OFF					
	2 COINS 1 CREDIT	ON	OFF	OFF					
	3 COINS 1 CREDIT	OFF	ON	OFF					
	1 COIN 2 CREDITS	ON	ON	OFF					
	1 COIN 3 CREDITS	OFF	OFF	ON					
	1 COIN 4 CREDITS	ON	OFF	ON					
	1 COIN 5 CREDITS	OFF	ON	ON					
	1 COIN 6 CREDITS	ON	ON	ON					
COIN CHUTE 2	1 COIN 1 CREDIT				OFF	OFF	OFF		
	2 COINS 1 CREDIT				ON	OFF	OFF		
	3 COINS 1 CREDIT				OFF	ON	OFF		
	1 COIN 2 CREDITS				ON	ON	OFF		
	1 COIN 3 CREDITS				OFF	OFF	ON		
	1 COIN 4 CREDITS				ON	OFF	ON		
	1 COIN 5 CREDITS				OFF	ON	ON		
	1 COIN 6 CREDITS				ON	ON	ON		
DISCOUNT to CONTINUE	NO DISCOUNT								OFF
	START 2 COINS CONTINUE 1 COIN								ON
NOT USED									

DIP SWITCH 2		SWITCH POSITIONS							
FUNCTIONS	SETTING	1	2	3	4	5	6	7	8
MONITOR SETTING 1	NORMAL	OFF							
	REVERSE VERTICAL	ON							
MONITOR SETTING 2	NORMAL		OFF						
	REVERSE HORIZONTAL		ON						
ATTRACT SOUND	ON			OFF					
	OFF			ON					
DIFFICULTY LEVEL	NORMAL				OFF	OFF			
	EASY				ON	OFF			
	HARD				OFF	ON			
	HARDEST				ON	ON			
CONTINUE	CONTINUE MODE							OFF	
	NO CONTINUE							ON	
NOT USED									
TEST MENU	NORMAL GAME								OFF
	TEST MENU								ON

"FACTORY INSTALLED" SETTING

5. LAYOUT OF P.C.BOARDS



MAIN P.C.BOARD

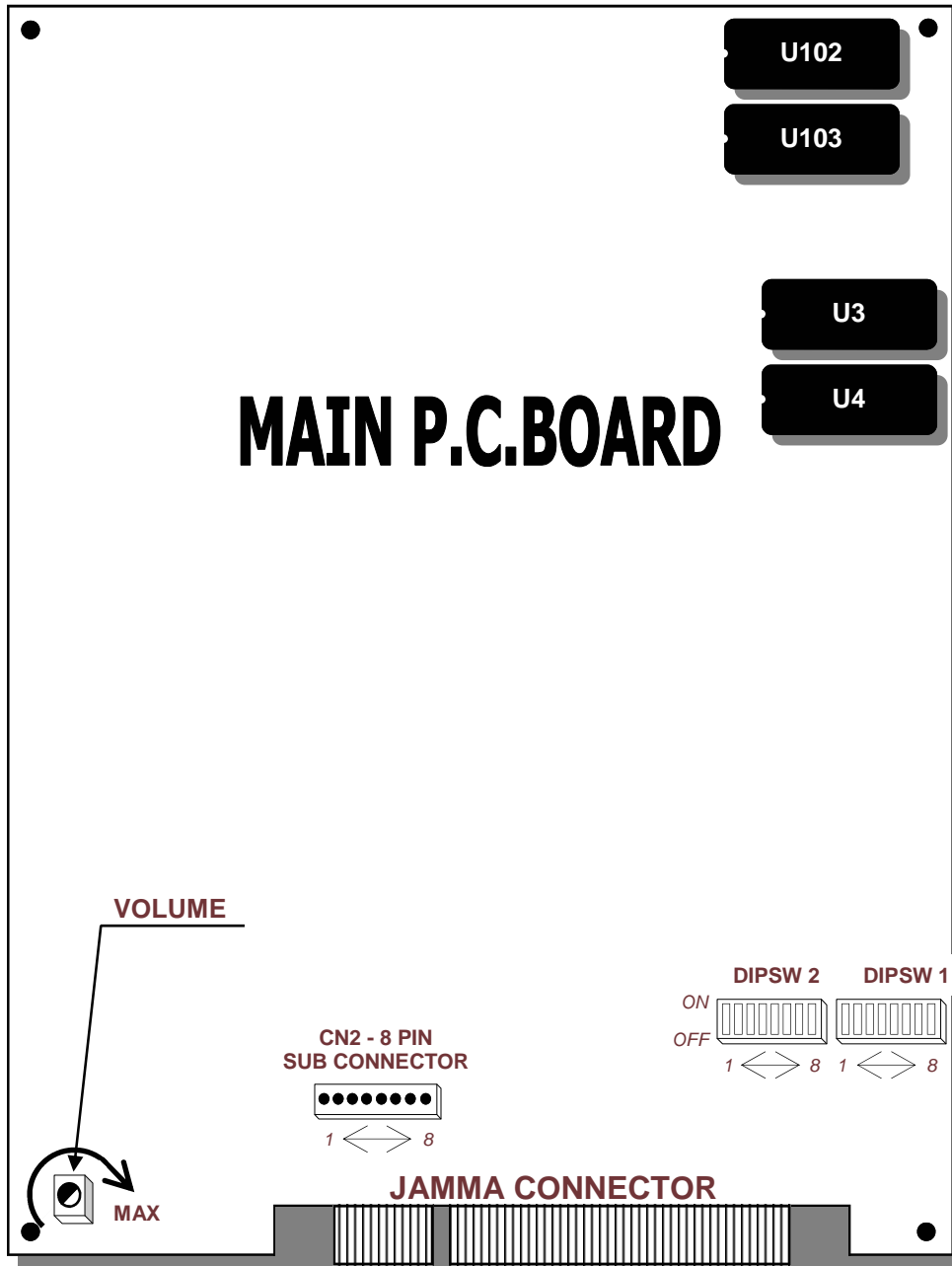

SOLENOID COIL INTERFACE BOARD

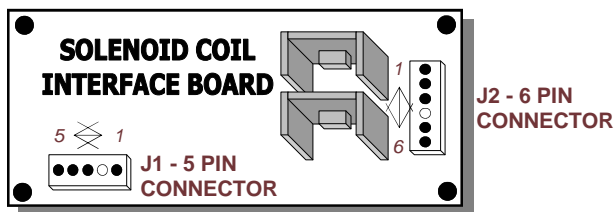

6. INTERFACE HARNESS DIAGRAM



JST - 8 PIN CONNECTOR

PIN	COLOR	FUNCTION
1	RED	+5VDC
2	ORG	1P GUN POT. (X)
3	ORG/	1P GUN POT. (Y)
4	GRN	2P GUN POT. (X)
5	GRN/WHT	2P GUN POT. (Y)
6	VIO	1P COIL PULSE
7	VIO/WHT	2P COIL PULSE
8	BLK	GND

J1 - 5 PIN CONNECTOR (MOLEX/FEMALE)

PIN	COLOR	FUNCTION
1	RED	+5VDC
3	BLK	GND
4	VIO	1P COIL PULSE
5	VIO/WHT	2P COIL PULSE

PIN	COLOR	FUNCTION
1	GRN/BLU	1P COIL
2	GRN/YEL	2P COIL
3	ORG	+21VDC, COIL
5	BLK/YEL	GND, COIL
6	BLK/YEL	GND, COIL

J2 - 6 PIN CONNECTOR (MOLEX/FEMALE)

P4 - 15 PIN CONNECTOR (MALE)

PIN	COLOR	FUNCTION
1	RED	+5VDC, 1P POT.
2	RED	+5VDC, 2P POT.
4	ORG	1P GUN POT. (X)
5	ORG/	1P GUN POT. (Y)
6	GRN	2P GUN POT. (X)
7	GRN/WHT	2P GUN POT. (Y)
13	BLK	GND, 1P POT.
14	BLK	GND, 2P POT.

P5 - 13 PIN CONNECTOR (MALE)

PIN	COLOR	FUNCTION
1	BLK	GND, 1P POT.
2	BLK	GND, 2P POT.
3	GRN/WHT	2P GUN POT. (Y)
4	GRN	2P GUN POT. (X)
5	ORG/	1P GUN POT. (Y)
6	ORG	1P GUN POT. (X)
10	RED	+5VDC, 1P POT.
11	RED	+5VDC, 2P POT.

PIN	COLOR	FUNCTION
1	GRN/YEL	2P COIL
4	GRN/BLU	1P COIL

P3 - 7 PIN CONNECTOR (MALE)

PIN	COLOR	FUNCTION
9	GRN/YEL	2P COIL
10	GRN/BLU	1P COIL

P10 - 10 PIN CONNECTOR

NOTE: P4 - 15 PIN and P3 - 10 PIN Connector are using for **REVOLUTION X**.
P5 - 13 PIN and P10 - 10 PIN Connector are using for **TERMINATOR 2**.

ORANGE

BLACK/YELLOW

7. HOW TO ASSEMBLE THE KIT



1. Change the GAME CABINET

- **MARQUEE STYRENE**

Change the old marquee to the ZOMBIE RAID Marquee Styrene.

NOTE: If the ZOMBIE RAID Marquee Styrene does not fit your cabinet, you should cut the marquee to fit your cabinet size.

- **CONTROL PANEL**

Change the parts on the control panel. Take off the old gun assys and the old push button assys from the control panel. Then put on the ZOMBIE RAID Control Panel Overlay and cover the Control Panel Overlay with the Clear Lexan Control Panel Cover.

NOTE: After you put on the ZOMBIE RAID Control Panel Overlay and the Clear Lexan Control Panel Cover, you must make the holes for the ZOMBIE RAID Gun Assys and Push Button Assys.

The RED Push Button Assys are for 1P and the BLUE Push Button Assys are for 2P. After that, put on the 4 ZOMBIE RAID Push Button Assys and the 2 ZOMBIE RAID Gun Assys.

- **INSTRUCTION DECAL SHEET**

Put ZOMBIE RAID Instruction Decal Sheet on the front glass of the cabinet.

NOTE: If the ZOMBIE RAID Instruction Decal Sheet does not fit your cabinet, you should cut the sheet to fit your cabinet size.

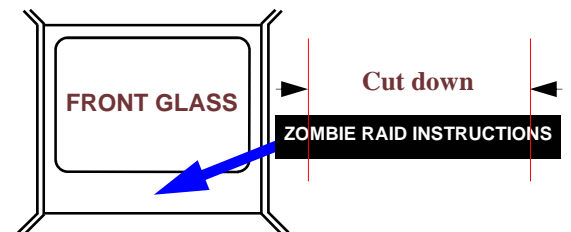

2. Put on the new P.C.BOARDS

- **MAIN P.C.BOARD**

After removing the old P.C.Boards, put the ZOMBIE RAID MAIN P.C.Board in the same place.

- **SOLENOID COIL INTERFACE BOARD**

Put the ZOMBIE RAID Solenoid Coil Interface Board nearby the Main P.C.Board.

NOTE: The ZOMBIE RAID game does not need the Sound Board.

If your game is a **REVOLUTION X**, you have to take off the old Sound Board from your **REVOLUTION X** cabinet when you remove the old P.C.Board.

3. Connect the INTERFACE HARNESS

NOTE: There are two types of setting styles in these instructions.

If your game is **REVOLUTION X**, see **WIRING INSTRUCTIONS FOR REVOLUTION X** (Page 11).

If your game is **TERMINATOR 2**, see **WIRING INSTRUCTIONS FOR TERMINATOR 2** (Page 12).

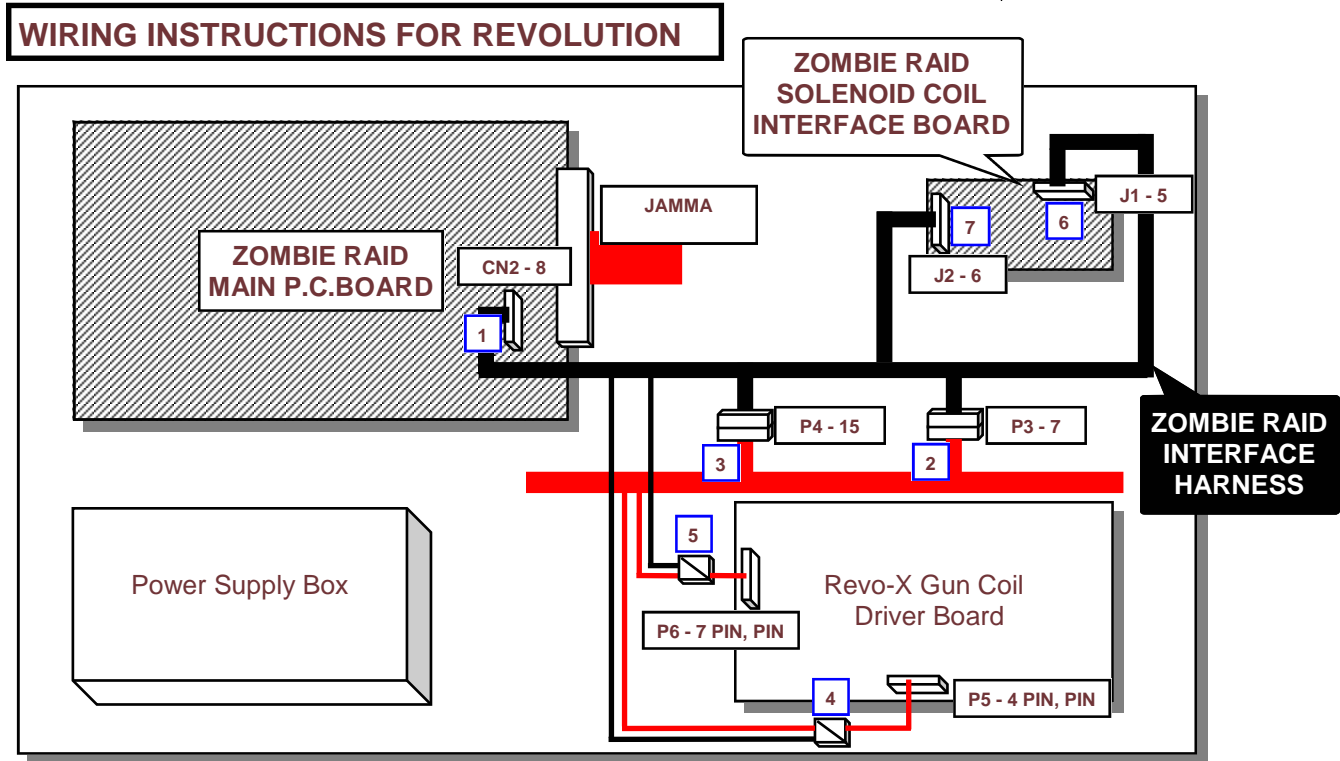

- 1: Connect the JST - 8 PIN Connector of the ZOMBIE RAID Interface Harness to the CN2 - 8 PIN Sub Connector on the ZOMBIE RAID Main P.C.Board.
- 2: Pull off the P3 - 7 PIN Connector from the REVO-X Gun Coil Driver Board. Then connect the P3 - 7 PIN Connector to the P3 - 7 PIN of the ZOMBIE RAID Interface Harness.
- 3: Connect the P4 - 15 PIN of the ZOMBIE RAID Interface Harness to the P4 - 15 PIN Connector which had been connected on the REVO-X Main P.C.Board.
- 4: Connect the BLACK/YELLOW wire (GND) of the ZOMBIE RAID Interface Harness to the #1 Pin of the P5 - 4 PIN Connector from the REVO-X Gun Coil Driver Board with the Tap Connector.
- 5: Connect the ORANGE wire (+21VDC) of the ZOMBIE RAID Interface Harness to the #1 Pin of the P6 - 7 PIN Connector from the REVO-X Gun Coil Driver Board with the Tap Connector.
- 6: Connect the J1 - 5 PIN Connector of the ZOMBIE RAID Interface Harness to the J1 - 5 PIN Connector on the ZOMBIE RAID Solenoid Coil Interface Board.
- 7: Connect the J2 - 6 PIN Connector of the ZOMBIE RAID Interface Harness to the J2 - 6 PIN Connector on the ZOMBIE RAID Solenoid Coil Interface Board.

WIRING INSTRUCTIONS FOR TERMINATOR

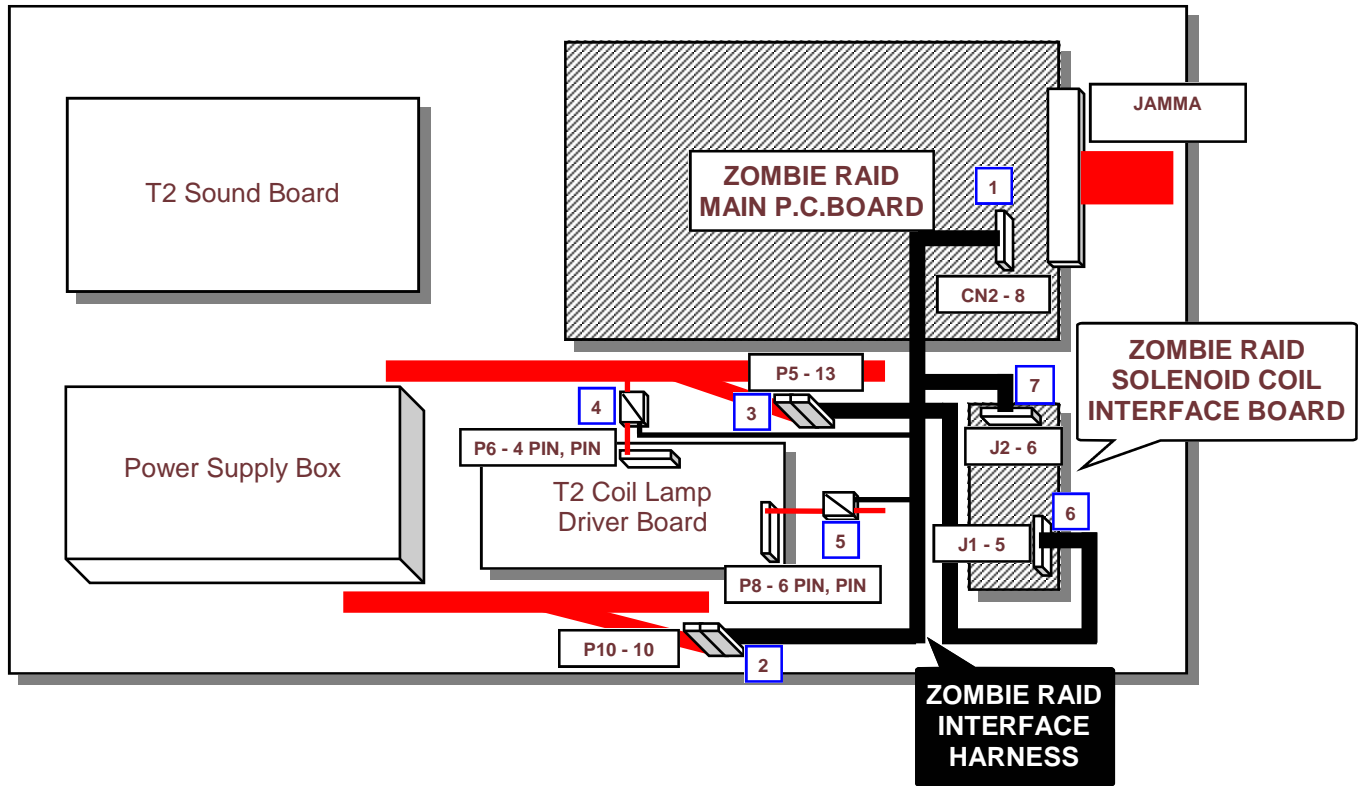

- 1: Connect the JST - 8 PIN Connector of the ZOMBIE RAID Interface Harness to the CN2 - 8 PIN Sub Connector on the ZOMBIE RAID Main P.C.Board.
- 2: Pull off the P10 - 10 PIN Connector from the T2 Coil Lamp Driver Board. Then connect the P10 - 10 PIN Connector to the P10 - 10 PIN of the ZOMBIE RAID Interface Harness.
- 3: Pull off the P5 - 13 PIN Connector from the T2 Coil Lamp Driver Board. Then connect the P5 - 13 PIN Connector to the P5 - 13 PIN of the ZOMBIE RAID Interface Harness.
- 4: Connect the BLACK/YELLOW wire (GND) of the ZOMBIE RAID Interface Harness to the #1 Pin of the P6 - 4 PIN Connector from the T2 Coil Lamp Driver Board with the Tap Connector.
- 5: Connect the ORANGE wire (+21VDC) of the ZOMBIE RAID Interface Harness to the #1 Pin of the P8 - 6 PIN Connector from the T2 Coil Lamp Driver Board with the Tap Connector.
- 6: Connect the J1 - 5 PIN Connector of the ZOMBIE RAID Interface Harness to the J1 - 5 PIN Connector on the ZOMBIE RAID Solenoid Coil Interface Board.
- 7: Connect the J2 - 6 PIN Connector of the ZOMBIE RAID Interface Harness to the J2 - 6 PIN Connector on the ZOMBIE RAID Solenoid Coil Interface Board.

8. TEST MENU



Entering the

If you need to check the condition of the game circuitry and controls, you can use the TEST MENU. Turn ON "DIP SWITCH 2, #8" and re-power on the game. The game will go into TEST MENU (Diagnostics) and the screen appears as follows:

Select TEST

Use this screen to choose which of the 7 screens you want to see. Move cursor using the TRIGGER or the PUMP SWITCH.

Then press the 1P Start Button to enter the test.

Returning to

Turn OFF "DIP SWITCH 2, #8" and re-power on the game. The game will go back to GAME MODE.

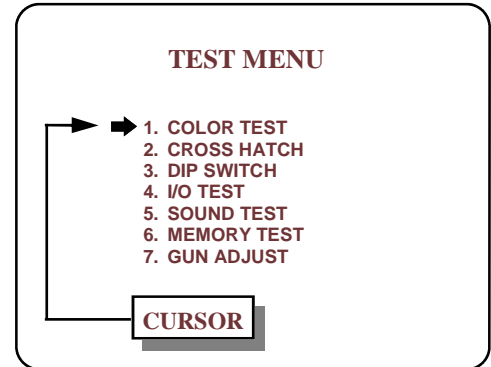

1. COLOR TEST

Use this screen to check the color of monitor. The color blocks in the center should be four bands (White, Red, Green, and Blue from top to bottom), each with a color scale from bright to dark, left to right. If the screen does not match this description, adjust the Monitor as described in the Monitor's manual.

- * Pull the TRIGGER or the PUMP SWITCH. You will exit and go back to the TEST MENU screen.
- * Press the 1P Start Button or the 2P Start Button. You can go to next test (CROSS HATCH).

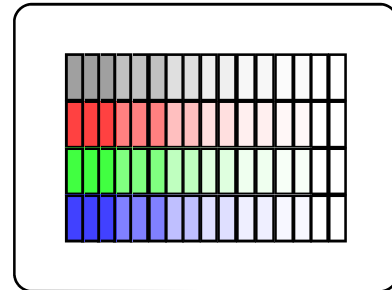

2. CROSS

Use this screen to check the size of picture. The CROSS HATCH test pattern has a White grid on a Black background. Check following:

- The grid line should be straight, and the lines should not have excessive pincushion or barrel distortion.
- "Out" line of grid line is the same size as "Out" line of game screen. So, "Out" line should be able to be seen with no overflow of grid lines on screen.

If these are not as above, adjust the Monitor as described in the Monitor's manual.

- * Pull the TRIGGER or the PUMP SWITCH or the 2P Start Button. You can exit and go back to the TEST MENU screen.
- * Press the 1P Start Button. You can go to next test (DIP SWITCH).

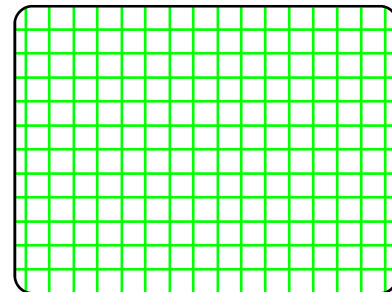



3. DIP SWITCH

Use this screen to see how all the DIP Switches are set.
 You can view and change the coinage and game options on this screen.
 The coinage and game option setting are explained on the DIP SWITCH TABLE.
 (Page 3) To change a setting, slide the appropriate toggle on the DIP Switch to ON or OFF. The screen will immediately display those changes.

DIP

COIN CHUTE A : 1 COIN 1 CREDIT
 COIN CHUTE B : 1 COIN 1 CREDIT
 HALF COIN : OFF
 CONTINUE : OFF
 SCREEN FLIP : OFF
 MIRROR : OFF
 DEMO SOUND : OFF
 GAME LEVEL : NORMAL
 12345678
 DIP SW 1 : 11111111 <0:ON, 1:OFF>
 DIP SW 2 : 11111110

NEXT 1P START BUTTON
 EXIT 2P START BUTTON

4. I/O TEST

Use this screen to check the volume X & Y, the coin switches and any other switches in this game. To check the functioning of each switch, activate it and watch the corresponding OFF letters change to ON.
 (You can check the function of solenoid coil on this screen. The solenoid coil will move by pulling the TRIGGER; SHOT 1 letters change OFF to ON.)
 If the ON and OFF letters do not appear correctly, check the Harness connections and Switches.

I/O TEST

VOLUME	1P	2P
X :	0000	0000
Y :	0000	0000
BUTTON		
SHOT 1 :	OFF	OFF
SHOT 2 :	OFF	OFF
START :	OFF	OFF
SERVICE :	OFF	OFF
COIN A :	OFF	
COIN B :	OFF	

NEXT 1P & 2P START BUTTON

5. SOUND TEST

Use this screen to check all game sounds. Choose a sound with the TRIGGER of the 1P Gun. Then pull the PUMP SWITCH. You can check each sound in this game.

SOUND

SOUND CODE
 00H
 xxxx STOP SOUND xxxx

SELECT : TRIGGER
 START : STOCK

NEXT 1P START BUTTON
 EXIT 2P START BUTTON

6. MEMORY TEST

Use this screen to check RAM and ROM on the Main P.C.B. The Main P.C.B. will automatically check them when you enter this screen. If no problems, the letters of **OK** will appear on screen.
 If you get the letters of **ERROR**, check the mounting of RAMs or ROMs on the Main P.C.B. and also if **ERROR** reappears, it needs to be replaced.

MEMORY

WORK RAM : OK
 OBJ RAM : OK
 COLOR RAM : OK
 ROM(EVEN) : OK
 ROM(ODD) : OK

NEXT 1P START BUTTON
 EXIT 2P START BUTTON

7. GUN ADJUST

Use this screen to adjust the GUNs. Choose setting style with the cursor. Move the cursor with the TRIGGER or the PUMP SWITCH and press the 1P or 2P Start Button.

- GUN ADJUST

When you choose **GUN ADJUST**, you go to next screen which is manual adjustment. (See below "HOW TO MANUALLY ADJUST THE GUN")

- FACTORY SETTING

When you choose **FACTORY SETTING**, the GUNs will adjust automatically. After setting, screen will show "GOOD LUCK TO YOU!!".

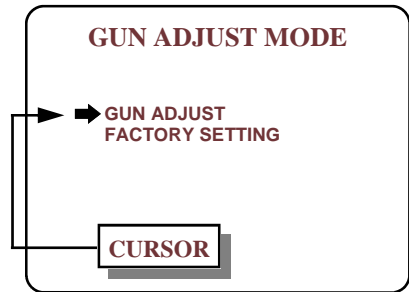

HOW TO MANUALLY ADJUST THE

1: Aim at lower left corner with the 1P GUN and pull the TRIGGER.

GUN ADJUST

AIM AT
LOWER LEFT SIGHT
AND PULL TRIGGER

<p><u>PLAYER 1</u> <u>SIGHT</u></p> <p><u>1</u></p> <p>X : 0000 Y : 0000</p> <p>SIGHT 2 X : 0000</p>	<p>PLAYER 2</p> <p>SIGHT 1 X : 0000 Y : 0000</p> <p>SIGHT 2 X : 0000 Y : 0000</p>
---	--

Shoot here with the 1P GUN

2: Aim at upper right corner with the 1P GUN and pull the TRIGGER.

GUN ADJUST

AIM AT
UPPER RIGHT SIGHT
AND PULL TRIGGER

<p><u>PLAYER 1</u> <u>SIGHT 1</u></p> <p>X : 0000 Y : 0000</p> <p><u>SIGHT</u></p> <p><u>2</u> X : 0000</p>	<p>PLAYER 2</p> <p>SIGHT 1 X : 0000 Y : 0000</p> <p>SIGHT 2 X : 0000 Y : 0000</p>
--	--

Shoot here with the 1P GUN

3: Aim at lower left corner with the 2P GUN and pull the TRIGGER.

4: Aim at upper right corner with the 2P GUN and pull the TRIGGER.

5: After setting, the screen will show "GOOD LUCK TO YOU!!".

GOOD LUCK TO

6: Turn back to OFF the "DIP SWITCH 2, #8" and re-power on the game. The game will go back to the GAME SCREEN.

Limited warranty, Repair and Return Policy

American Sammy Corporation warrants all products to be free from defective materials and workmanship for a period of thirty (30) days from the American Sammy Corporation invoice date unless otherwise specified in writing by American Sammy Corporation. The extent of this warranty applies to all electronic assemblies only, and does not include lamps and fuses.

This limited warranty is invalid for any product that upon examination, is deemed to have been subject to misuse, improper repair or installation, neglect or violation of specification or other instructions published by American Sammy Corporation.

There are no additional warranties which extend beyond those limited warranties described above.

The limited warranties described above shall be in lieu of any other warranty, express or implied, including but not limited to any implied warranty of merchantability or fitness for a particular purpose.

Return Merchandise Authorization

1. Contact your authorized ASC distributor to receive a Return Merchandise Authorization for return.
2. You must obtain RMA numbers from American Sammy Corporation through an authorized ASC distributor. Please have your serial number available when calling for an RMA number.
3. All items must have an RMA number marked clearly on the outside of the package.
4. Products must be shipped prepaid. Products returned without an RMA number will not be accepted.
5. Credits to accounts are subject to inspection of products for damage and suitability for resale.